



GOLDRING
Lenco

INSTRUCTION MANUAL

“GL 78”

TRANSCRIPTION UNIT

GOLDRING LIMITED



INSTRUCTION MANUAL FOR GOLDRING-LENCO "GL 78" TRANSCRIPTION UNIT.

It is recommended that these instructions be carefully read before unpacking the Unit.

DESCRIPTION

The Goldring-Lenco GL.78 is a precision engineered transcription turntable unit suitable for the reproduction of both mono and stereo records. It is available in chassis form (GL.78) for mounting in a cabinet, or as GL.78/P already fitted to a special plinth.

The turntable, which is die-cast from non-ferrous materials, is dynamically balanced and weighs 9 lbs. It is driven by a 4-pole constant velocity motor via a rubber rimmed idler wheel and the total wow and flutter is as low as 0.06%. The unique vertical drive system allows the turntable speed to be continuously varied from 86 r.p.m. down to 30 r.p.m. and from 18-15 r.p.m. The standard playing speeds of 78, 45, 33 and 16 are located by adjustable pre-set click-in positions.

The pick-up arm for this unit is of lightweight construction with a removeable perforated plug-in shell. It has calibrated stylus pressure adjustment by means of a sliding counter balance weight, and a template is provided to ensure correct alignment of the stylus for minimum distortion.

Anti-skating bias compensation is also fitted, and as a further protection for records the arm is gently lowered and raised by a viscously damped pick-up lowering device.

At the end of a record the unit will automatically switch itself off, and the pick-up will automatically be raised from the record. Simultaneously the idler wheel will be disengaged from the motor, thereby preventing "flats" appearing on it.

An entirely new viscously damped suspension system is fitted to the GL.78, and this effectively prevents acoustic feedback and also absorbs any shock which might be transmitted to the pick-up from the floor.

The GL.78 is built to instrument standards of quality and will satisfy even the most demanding of music lovers.

SPECIFICATION

General

Dynamically balanced turntable.
Viscously damped lowering arm for pick-up.
Turntable speed infinitely variable between 30 and 86 r.p.m. with locations for 16 $\frac{2}{3}$, 33 $\frac{1}{3}$, 45 and 78 r.p.m.
Viscously damped mountingsprings.
Wow and flutter linear $\pm 0.11\%$.
Wow and flutter weighted to DIN 45507 $\pm 0.06\%$.
Hum level from magnetic cartridges -60 dB.
Rumble weighted to DIN 45539 -60dB.
Speed change for a 10% change in mains voltage $\pm 0.2\%$.
Maximum deviation of speed using a cartridge tracking at 6p 0.3%.

Pick-up Arm:

Pick-up arm with counterweight, and knife-edged bearings.
Adjustable stylus pressure from 0.5 - 5 grms.

Removeable plug-in shell of light metal to accommodate most pick-up cartridges.

Total length of arm 314mm.

Tracking distance between vertical spindle and turntable spindle 210mm
Stylus overhang 17.1mm.

Adjustment for stylus position 12 mm.

Tracking angle 23° 12 minutes.

Tracking error with correct setting for stylus $\pm 0.8^\circ$

Motor:

4-pole motor with conical spindle, switchable 110v/220v/50Hz, and also available for 110v/60Hz.

Shut-off Switch:

The GL.78 features a new mechanical shut-off which switches off the unit and raises the pick-up arm at the end of the record. This shut-off mechanism can be disconnected if not required, for example for lan-

guage courses, by turning the knob to "MANUAL".

Dimensions:

Baseplate of 2mm thick steel 385 x 330mm.

Height required above baseplate 55 mm.

Depth required below baseplate 75 mm.

Turntable diameter 312mm.

Component Weights:

Balanced die-cast zinc turntable, 4 Kg.

Total weight of chassis 8.5 Kg.

Total weight of chassis with packing 10.5 Kg.

1. UNPACKING. This unit was carefully checked before leaving the factory. Observe the condition of the packing carton for signs of improper handling in transit. If damage is apparent make an immediate claim to the dealer from whom you made the purchase. Check that all items shown in paragraph (4) are complete.

The rear section of the arm is decoupled and does flex and droop slightly when the counterweight is fitted. This feature should not be mistaken for damage.

2. BASEBOARD. (Chassis model only). The unit should be mounted on a wooden baseboard about $\frac{1}{2}$ "- $\frac{3}{4}$ " thick of somewhat the size as outlined on the enclosed template sheet.

The baseboard should be cut so as to provide one large cut-out, and drilled for four holes of $1\frac{1}{4}$ " diameter.

The position of the cut-out and the holes may be obtained by either of these two methods:—

- (a) Cover the baseboard with carbon paper laid face downwards and fix the template in the desired position with drawing pins at the given centres; then scribe on the heavy outline of the cut-out, so that the line is reproduced on the baseboard by the carbon paper
- (b) Attach template to the baseboard with self-adhesive tape or with pins, and prick through the template with a sharp pointed instrument such as a scribe or a bradawl.

3. CABINET CLEARANCE. (Chassis model only). Top clearance: $2\frac{1}{2}$ " above top surface of wooden baseboard.

Bottom clearance: 3" below top surface of wooden base-board.

4. CONTENTS OF CARTON. The following items are contained in the carton:—

- (a) Turntable.
- (b) Rubber turntable mat.
- (c) Motor unit complete with pick-up arm.
- (d) Headshell for pick-up arm.
- (e) Large sliding weight for pick-up arm. (1)
- (f) Small sliding weight. (5)
- (g) Mounting screws for pick-up cartridge.
- (h) Circular plastic moulding for use with 45 r.p.m. records with 1½" centre hole.
- (i) Envelope containing mounting components for unit. (Chassis model only).
- (j) Stroboscope.
- (k) Components for bias compensation, consisting of notched guide rod (3), corkscrew rod on clip (28) and two weights (27).

5. WARNING. The motor (31) is held in position by two screws (19) for safety in transit. Before the unit can be played these must be loosened completely until the motor is freely sprung.

6. TURNTABLE. Place the turntable over the centre spindle (18), ensuring that it is properly seated. Place loose rubber mat over centre spindle. In order to remove the turntable apply a sharp tap with a wooden block to the centre spindle while lifting the turntable.

7. HEADSHELL. The GL.78 is supplied with a plug-in head complete with mounting screws to accommodate most cartridges. If various cartridges are to be used, e.g. to play older 78 r.p.m. shellac records, we suggest that a separate plug-in head be used for each cartridge to facilitate the change from one to another.

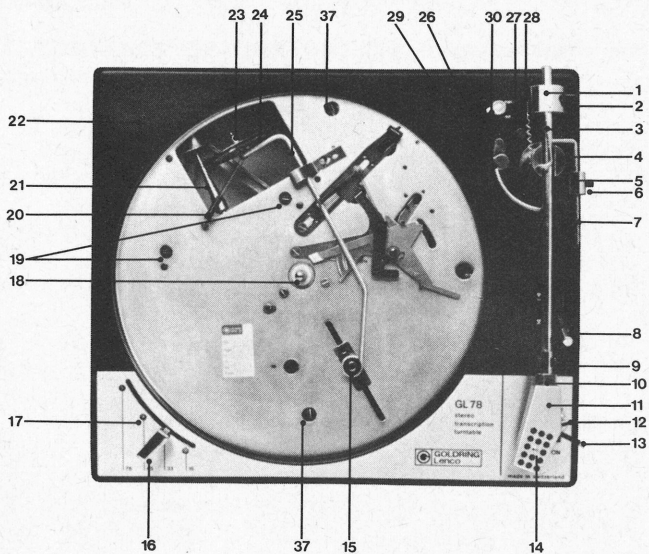

FIG. 1.

LARGE COUNTER WEIGHT.....	1
COUNTERWEIGHT FIXING SCREW.....	2
NOTCHED GUIDE ROD.....	3
PEDESTAL BASE.....	4
STYLUS PRESSURE ADJUSTMENT WEIGHT.....	5
FIXING SCREW FOR STYLUS PRESSURE ADJUSTMENT WEIGHT.....	6
CALIBRATED OUTRIDER.....	7
ARM LIFTING LEVER.....	8
PICK-UP REST.....	9
KNURLED HEAD SECURING RING.....	10
PLUG-IN HEAD.....	11
ON-OFF SWITCH.....	12
FINGER LIFT.....	13
CARTRIDGE MOUNTING PLATE ADJUSTING SCREW.....	14
IDLER WHEEL ARM SECURING CLIP.....	15
SPEED CONTROL LEVER.....	16
SPEED CATCH SET SCREW.....	17

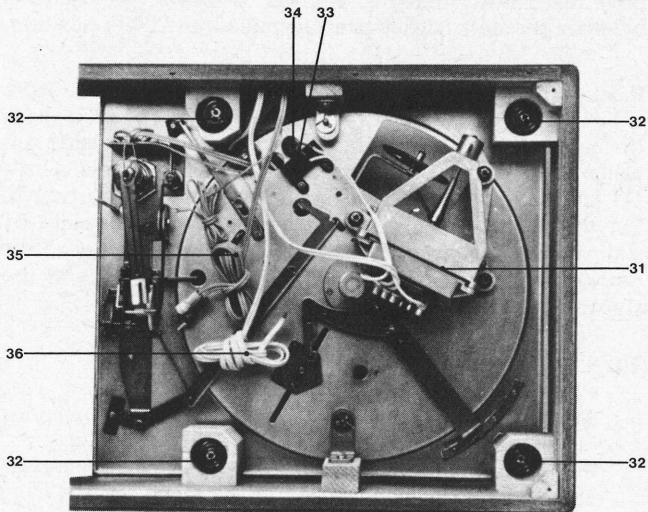

FIG. 2.

CENTRE SPINDLE	18
MOTOR TRANSIT SCREWS	19
IDLER WHEEL SPRING	20
CONICAL MOTOR SPINDLE	21
HOLE FOR MOUNTING LENCOCLEAN	22
IDLER WHEEL RETAINING NUTS	23
IDLER WHEEL	24
IDLER WHEEL ARM	25
KNURLED HEIGHT ADJUSTMENT SCREW	26
ANTI-SKATING WEIGHT	27
CORKSCREW	28
PICK-UP LOWERING ARM	29
MANUAL/AUTO STOP SWITCH	30
MOTOR	31
VISCOUSLY DAMPED SUSPENSION SPRINGS	32
MAINS SWITCH	33
SWITCH CLICK SUPPRESSING CONDENSER	34
PICK-UP LEADS	35
MAINS LEAD	36
TRANSIT SCREW	37

N.B. Before tipping the unit to adjust its level, it is imperative that the turntable is removed. However, for checking whether the unit is level the turntable must be in position.

9. PLAYING WEIGHT. Place small weight (5) on outrider (7) and push back as far as it will go. Place large weight (1) on back of arm, and with the arm free to move slide this weight forward until arm is balanced. Rotate large weight (1) until the arm neither swings inwards nor outwards. Set the stylus pressure recommended for the cartridge by sliding the small weight forward. (Each graduation on the outrider equals 0.5 grms. read from the front face of the stylus pressure weight).

10. LOWERING DEVICE

Place a record on the turntable.

Move pick-up arm to playing position until the stylus is just above the record.

Pull lowering device control lever (8) forward and let stylus come into contact with the record.

Check that the pick-up arm is horizontal. If not, loosen screws in pedestal base (4) and move the pedestal up or down until the arm is level. Tighten screws.

Turn knurled screw (26) on lowering arm (29) until there is a gap of $1/8''$ between it and the rubber buffer on the tone arm.

11. ANTI-SKATING DEVICE. This is to compensate against side thrust which increases the force of the stylus on the inner side of the groove and reduces it on the outer.

Press the notched guide rod (3) into hole in pedestal (4).

Push clip with corkscrew (29) on to pedestal base so that the pip locates in the hole in the front of the pedestal. (It might be found necessary to raise the height of the arm to achieve this. In this case the hexagon stand-off pillars should be used for mounting the cartridge).

See fig (3).

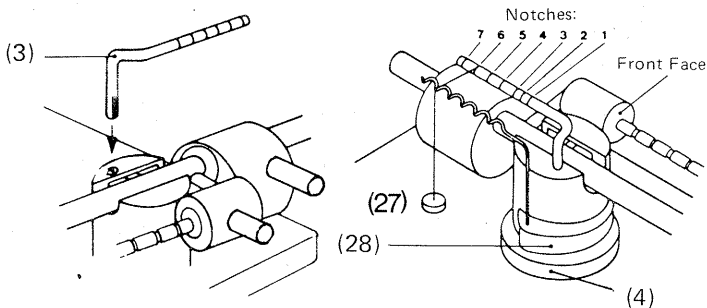

FIG. 3.

Before setting the anti-skating device check that the arm has been correctly set as described earlier. Setting of the correct anti-skating force depends on the stylus pressure. Two separate anti-skating weights are supplied with the GL.78, namely a 1 gm. and a 4 gm. weight. A list of settings for typical stylus pressures is shown on the Table on Page (11).

EXAMPLE

To set the anti-skating force for a cartridge for which the recommended stylus pressure is 2 grms. the Table shows that for a stylus pressure of 2 grms. the 4 gm. weight should be used on Notch 4. Therefore hang the 4 gm. weight over Notch 4, passing the thread over the adjacent hollow in the corkscrew (28) so that it hangs freely.

12. PICK-UP CONNECTIONS. The leads (35) from the pick-up arm are terminated in Phono plugs. These are standard and should fit the input of most amplifiers. The one colour coded red is the right-hand channel connection and should be plugged into the right-hand channel input of the amplifier. The one colour coded white is the left-hand channel and should be connected to the left-hand channel input of the amplifier.

13. MAINS SUPPLY. The unit is normally supplied for 200-250 volts 50 Hz AC mains. (Special motors for use on other mains voltage or frequency are available on request).

Connect mains lead (36) to the supply, ensuring that the On/Off switch (12) is in the "OFF" position.

A separate earth lead is fitted (this is the single lead terminated in a spade and adjacent to the main lead).

This should be connected to the amplifier "earth" or to a convenient external earth point. (In some cases this might create a hum loop and in these circumstances this lead should be ignored).

14. TO PLAY. Check that the pick-up leads are correctly connected and that the mains lead is plugged in with the mains switched on.

Set the speed control lever (16) to the correct speed for the record.

Place the pick-up arm on the lowering arm (29) so that the stylus is directly above the selected groove on the record.

Turn the On/Off knob (12) to "ON" and move lowering device control lever (8) forward.

The GL.78 is fitted with an automatic stop, so that at the end of the record the motor will switch off, the turntable stop, and the pick-up be lifted clear of the

STYLUS PRESSURE grams	WEIGHT grams	NOTCH
$\frac{1}{2}$	1	4
$\frac{3}{4}$	1	6
1	4	1
$1\frac{1}{4}$	4	2
$1\frac{1}{2}$	4	3
2	4	4
$2\frac{1}{2}$	4	5
3	4	6
$3\frac{1}{2}$	4	7

Table for the correct setting of anti-skating force according to stylus pressure.

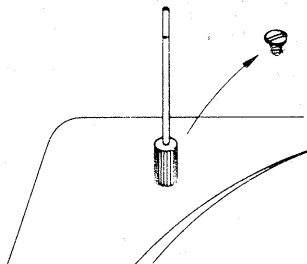

FIG. 4.

17. MAINTENANCE AND SERVICE. The motor bearings and turntable spindle bearings are self-lubricating and no further lubrication should be necessary. Should the slideway of the speed change mechanism run dry, then a small amount of vaseline should be applied. Care must always be taken that the underside of the turntable and the idler wheel must be kept clean and free from grease.

N.B. Use a clean, dry, non-fluffy cloth for cleaning. To remove grease, use a few drops of methylated spirit or carbon tetrachloride on the cloth.

IF the turntable does not rotate but the motor is going, then the idler wheel spring (20) needs replacing and the underside of the turntable should be cleaned with a solution of carbon-tetrachloride.

IF the motor does not operate when the unit is switched on, check that the mains are connected correctly. Should the motor still not operate, then a fault has developed and the motor should be repaired.

IF the motor continues to operate when the unit is switched off, then the switch click suppressing condenser (34) is faulty and should be replaced.

IF the speed is erratic or a rumble develops, then the idler wheel (24) should be cleaned with carbon tetrachloride as should be the underside of the turntable and the motor cone (21).

IF a flat has developed on the idler wheel, this should be replaced. To replace idler wheel remove the circlip (15) and unhook the spring (20). Lift out the idler wheel arm (25). The idler wheel/spindle is secured by a single nut (23) undo nut, remove old wheel & spindle & replace with new wheel/spindle taking care not to touch the rubber ring. Replace assembly and refit spring and circlip.

If the unit is to be transported for any reason, it is essential that the following precautions be taken:—

- (1) Remove large counterweight from rear of arm and the small weight from the outrider. Secure pick-up arm to rest.**
- (2) Remove the headshell complete with cartridge, and pack carefully as a separate item.**
- (3) Remove the turntable and pack as a separate item.**
- (4) Retighten motor transit screws.**
- (5) Tighten transit screws.**

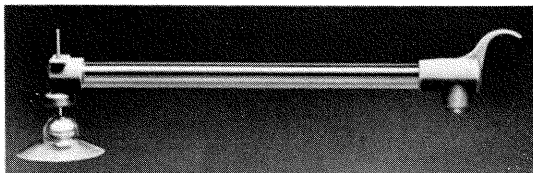

LENCOCLEAN

A unique record cleaning system which is easily fitted to the GL.78 is also available.

It brushes the records clean and dispenses a narrow band of fluid which eliminates electrostatic charges and cools the point of contact, reducing stylus and record wear.

RECOMMENDED CARTRIDGES

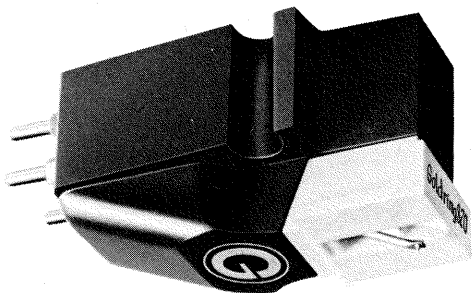

GOLDRING G.820 and G.820/E.

For High Quality Amplifiers, these new magnetic stereo cartridges employing the "free-field" principle have an exceptionally wide and flat frequency response and excellent separation at all frequencies. G.820 - G.820/E - G.820 Super E.

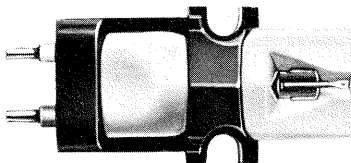

G.800

The well established range of G.800 Cartridges is also available and recommended for use with the GL.78.

IMPORTANT

If for any reason it is found necessary to return a Goldring/Lenco Turntable Unit to the Service Department, it is essential that full details are given as to the reason for return, Failure to comply with this request might result in delay of the return of goods. Furthermore, failure to comply with the instructions for transportation will result in damage to the unit.

